

SPECIFICATIONS

CONTACT RATING: 6A @125 VAC or 28 VDC
3A @250 VAC

ELECTRICAL LIFE: 30,000 make-and-break cycles at full load
CONTACT RESISTANCE: 10 mΩ max. initial @2-4 VDC, 100 mA
INSULATION RESISTANCE: 1,000 MΩ min.
DIELECTRIC STRENGTH: 1,500 V RMS @ sea level.
OPERATING TEMPERATURE: -30°C to +85°C

MATERIALS

CASE - diallyl phthalate (DAP)
SLIDE HANDLE - Nylon
HOUSING - Stainless Steel
CONTACT AND TERMINAL - Copper alloy, silver plated

How do you build the switches you need!!

The straight type , please see the (A) ;

The right angle P.C terminals, please see the (B)

(A) T S - 1 3 - A 1 - 2 - C Q - E - S 2 0 -

Switches Function		Actuator		Actuator color		Termination		Contact Material		Vertical support Bracket	
TS-13	SPDT on-none-on	A1	5.08	1	white	B	solder lug	Q	silver plated	(none)	
TS-13A	SPDT on-none-mom	A2	7.35	2	black (std.)	C	P.C	R	gold plated	S20	8.89 (SPDT)
TS-14	SPDT on-off-on	A3	9.40	9	gray	D	Quick connect	G	gold over silver	S20	10.16 (DPDT)
TS-11	DPDT on-none-on	A4	3.60			D1	wire wrap 19.05			S25	18.36 (SPDT)
TS-12	DPDT on-off-on	A5	5.08			D3	wire wrap 10.8				
		A6	12.32					Epoxy seal			
		A7	4.20					(none)	none seal		
		Wide Actuator						E	epoxy seal		
		S1	5.08							RoHS code	
											H = RoHS Compliant

(B) T S - 1 3 P - A 1 - 2 - Q - E -

Horizon Right Angle	Vertical Right Angle	Switches Function	Actuator		Actuator color		Contact Material		RoHS code	
TS-13P	TS-13L	SPDT on-none-on	A1	4.72	1	white	Q	silver plated	H = RoHS Compliant	
TS-13PA	TS-13LA	SPDT on-none-mom	A2	6.96	2	black	R	gold plated		
TS-14P	TS-14L	SPDT on-off-on	A3	8.96	9	gray	G	gold over silver		
TS-11P	TS-11L	DPDT on-none-on	A4	3.10						
TS-12P	TS-12L	DPDT on-off-on	A5	4.72						
			A6	11.92						
			Wide Actuator							
			S1	4.72						
								Epoxy seal		
								(none)	none seal	
								E	epoxy seal	

SPDT

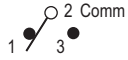
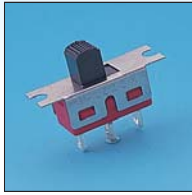

Model No.	Switching position		
TS-13	ON	NONE	ON
TS-13A	(ON)	NONE	ON
TS-14	ON	OFF	ON
Term. Comm.	2-3	open	2-1

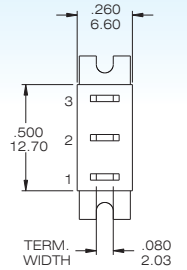
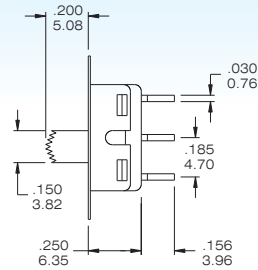
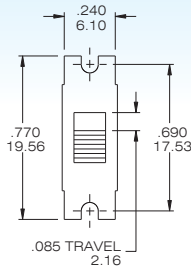

TS-13-A1-2-BQ

DPDT

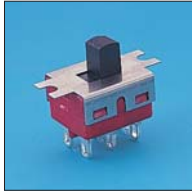

Model No.	Switching position		
TS-11	ON	NONE	ON
TS-12	ON	OFF	ON
Term. Comm.	2-3	open	2-1
	5-6		5-4

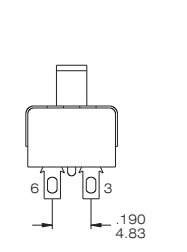
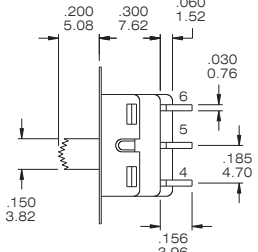
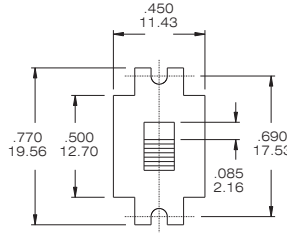

TS-11-A1-2-BQ

HORISON RIGHT ANGLE

SPDT

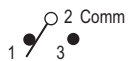
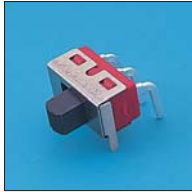

Model No.	Switching position		
TS-13P	ON	NONE	ON
TS-13PA	(ON)	NONE	ON
TS-14P	ON	OFF	ON
Term. Comm.	2-3	open	2-1

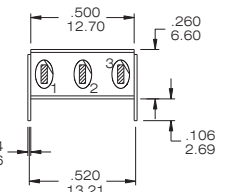
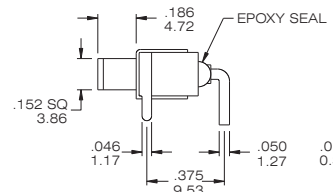
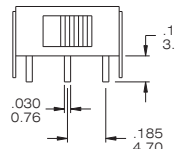

TS-13P-A1-2-Q(-E)

DPDT



Model No.	Switching position		
TS-11P	ON	NONE	ON
TS-12P	ON	OFF	ON
Term. Comm.	2-3	open	2-1
	5-6		5-4

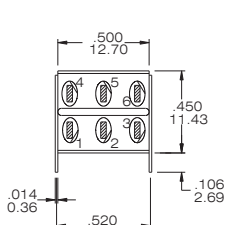
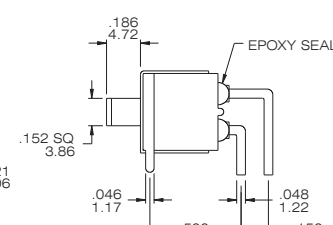
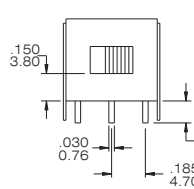

TS-11P-A1-2-Q(-E)

VERTICAL RIGHT ANGLE

SPDT

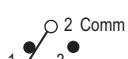

Model No.	Switching position		
TS-13L	ON	NONE	ON
TS-13LA	(ON)	NONE	ON
TS-14L	ON	OFF	ON
Term. Comm.	2-3	open	2-1

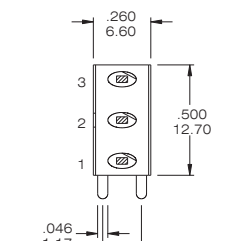
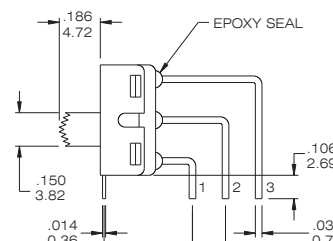
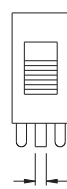

TS-13L-A1-2-Q(-E)

DPDT

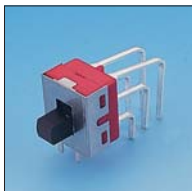

Model No.	Switching position		
TS-11L	ON	NONE	ON
TS-12L	ON	OFF	ON
Term. Comm.	2-3	open	2-1
	5-6		5-4

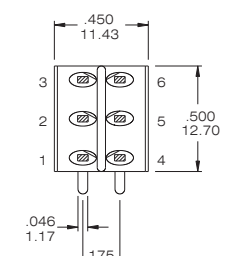
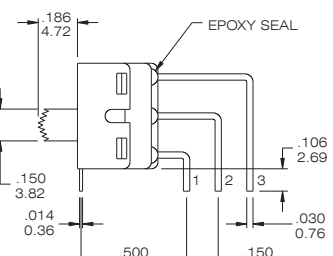
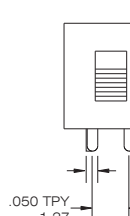

TS-11L-A1-2-Q(-E)

Actuator Option

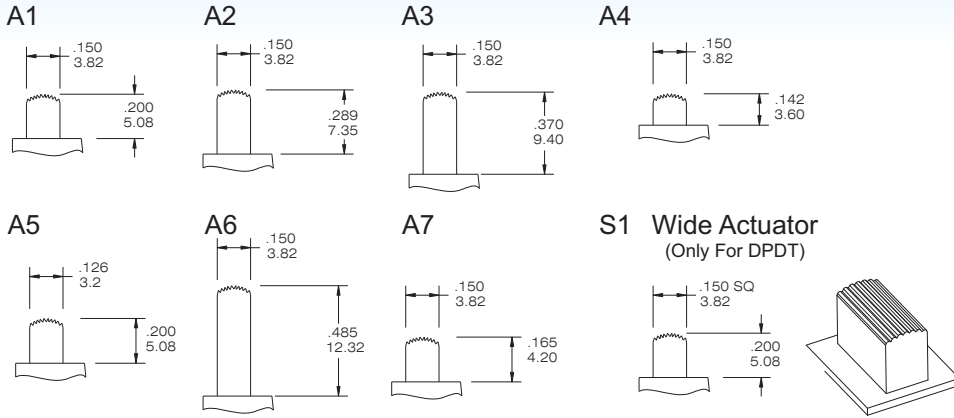

• the height of actuator is for the straight type. It will be shorter while applying in Right Angle type

Actuator Color

COLOR NO.	COLOR
1	white
2	black
9	gray

TERMINAL OPTION

Terminal Seal Option

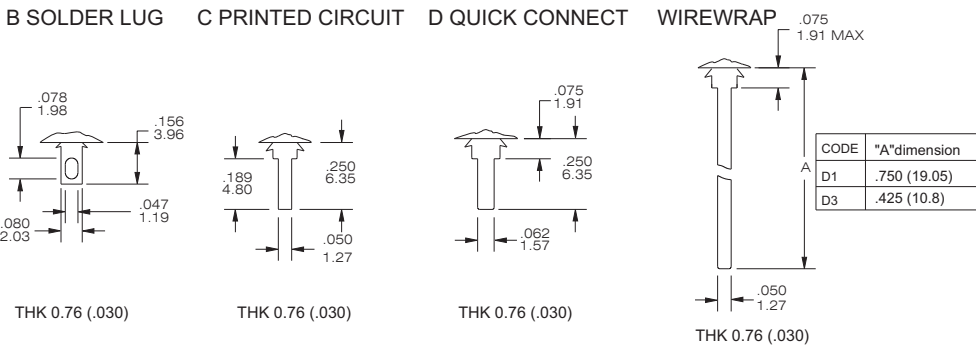

E TERMINAL SEAL



PANEL MOUNTING DIMENSION

THE P.C.B MOUNTING

TS-11/TS-13

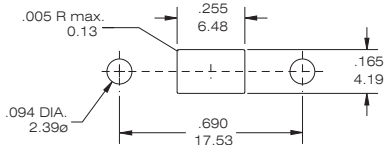

TS-12 / TS-14

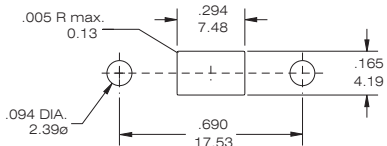

TS-13/TS-14

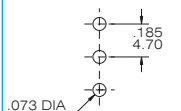

TS-11/TS-12

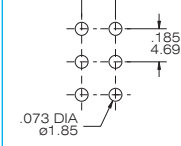

TS-13P/TS-14P

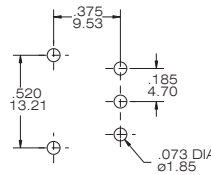

TS-11P/TS-12P

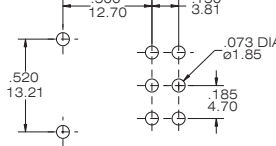

TS-13L/TS-14L

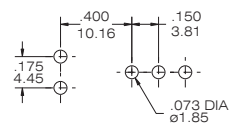

TS-11L/TS-12L

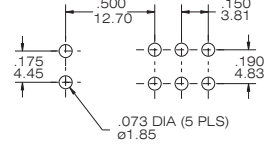

CONTACT MATERIAL OPTIONS

CODE	CONTACT MATERIAL	TERMINAL MATERIAL	RATING
Q	Silver plated	Silver plated	6 A @ 125V AC or 28 V DC; 3 A @ 250 VAC
R	Gold plated over nickel plated	Gold plated over nickel plated	0.4VA MAX @ 20 V AC or DC MAX
G	Gold plated over silver plated	Gold plated over silver plated	0.4 VA MAX @ 20 V AC or DC MAX or 6 A @ 125V AC or 28 V DC; 3 A @ 250 VAC
K	Gold plated over nickel plated	Tin over nickel plated	0.4VA MAX @ 20 V AC or DC MAX

* THE K option is only for some special item. Please inquire first when you need the "K" option



T80-S

Slide Switches



VERTICAL SUPPORT BRACKET OPTION

(only apply the straight type terminal - Please modify the terminal option is "c" code)

S20

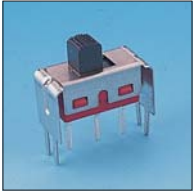

SPDT

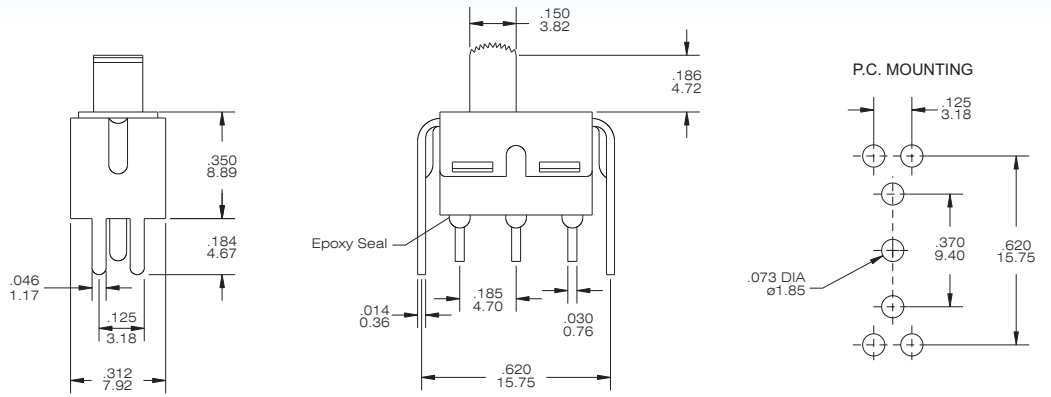

TS-13-A1-2-CQ-S20

S25



SPDT

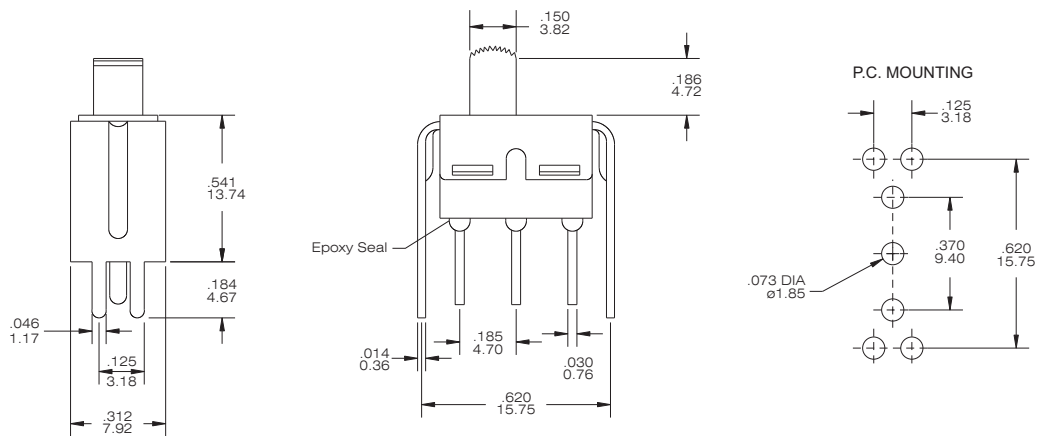

TS-13-A1-2-CQ-S25

S20

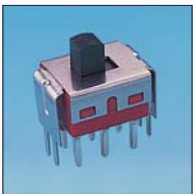

DPDT

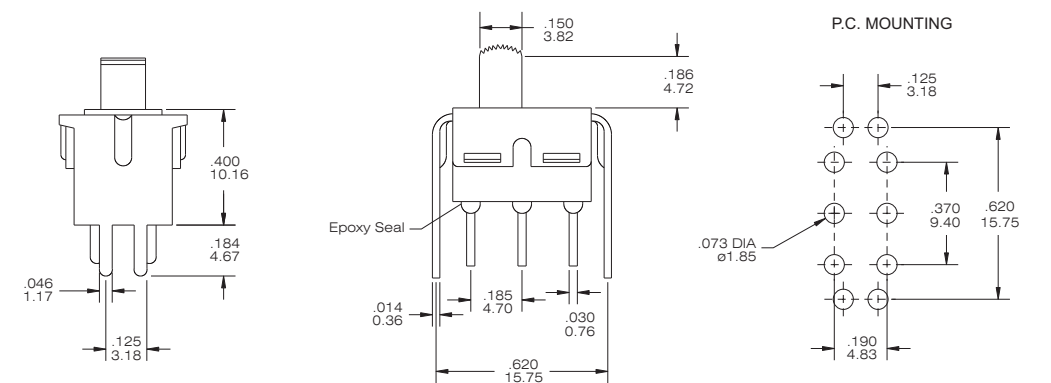

TS-11-A1-2-CQ-S20

INDEX

TOGGLE

ROCKER

SLIDE

PUSH BUTTON

DIP

TACT